

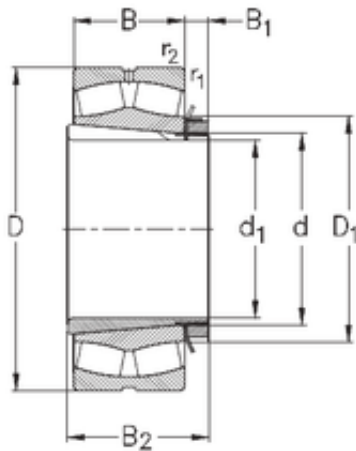

Qingdao Flow Group Limited

50 mm x 90 mm x 23 mm NKE 22210-E-K-W33+H310 spherical roller bearings

Bearing No. 22210-E-K-W33+H310



22210-E-K-W33+H310 Bearing 2D drawings and 3D CAD models

Size	50x90x23 mm
Bore Diameter	50 mm
Outer Diameter	90 mm
Width	23 mm
d	50 mm
d1	45 mm
D	90 mm
B	23 mm
C	23 mm
r1 min.	1,1 mm
r2 min.	1,1 mm
B1	13 mm
B2	42 mm
D1	70 mm
Weight	0,88 Kg
Basic dynamic load rating (C)	105 kN
Basic static load rating (C0)	124 kN
Limiting speed	7000 r/min
Calculation factor (e)	0,24
Calculation factor (Y0)	2,8
Calculation factor (Y1)	2,8