

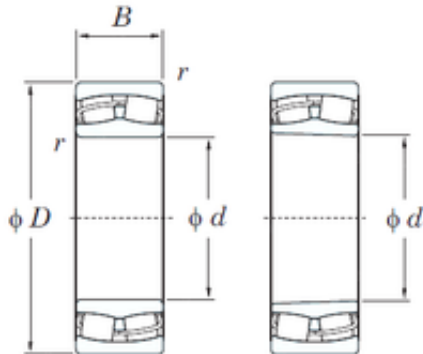

Qingdao Flow Group Limited

160 mm x 270 mm x 86 mm KOYO 23132RH
spherical roller bearings



Bearing No. 23132RH

Size	160x270x86 mm
Bore Diameter	160 mm
Outer Diameter	270 mm
Width	86 mm
d	160 mm
D	270 mm
B	86 mm
C	86 mm
r min.	2,1 mm
da min.	172 mm
Da max.	258 mm
ra max.	2 mm
Weight	20,8 Kg
Basic dynamic load rating (C)	848 kN
Basic static load rating (C0)	1430 kN
(Grease) Lubrication Speed	1200 r/min
(Oil) Lubrication Speed	1600 r/min
Calculation factor (e)	0,3
Calculation factor (Y0)	2,17
Calculation factor (Y1)	2,22

23132RH Bearing 2D drawings and 3D CAD models